

FILE NAME:

REVISIONS

ZONE	LTR	DESCRIPTION	DATE	APPROVED

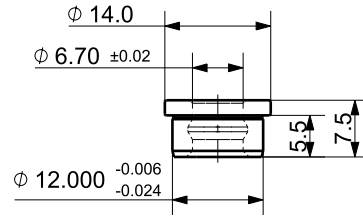
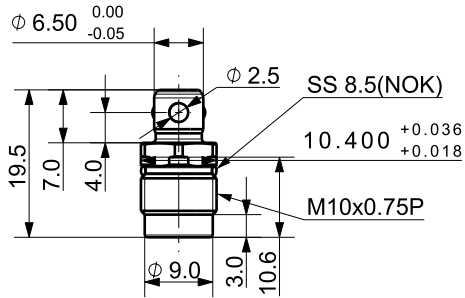
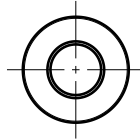
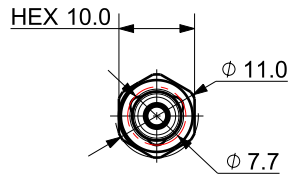

<BLC-0605B>

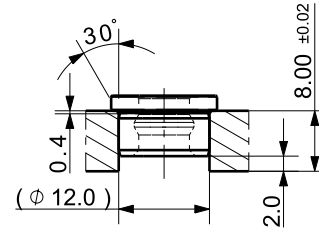

<MOUNTING>



Isometric view (1:1)

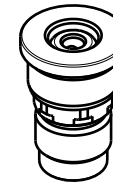

Isometric view (1:1)  
(installed with BUSH)

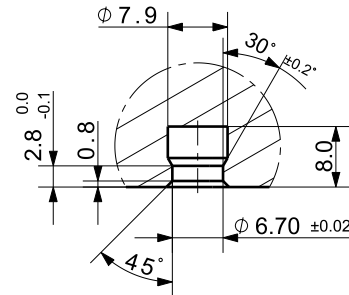

<Workpiece Hole Reference Dimensions>

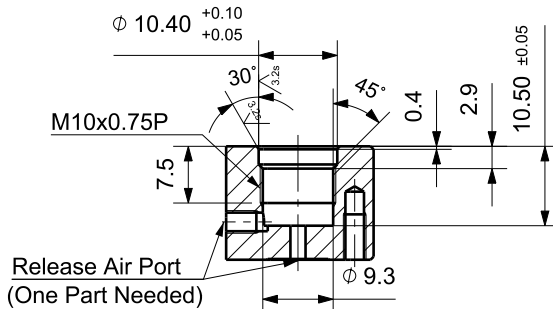

<MOUNTING DIMENSION>

DET.NO	NAME	Q'TY	MAT'L	FINAL SIZES & PART No	REMARK

UNLESS OTHERWISE SPECIFIED	SIGNATURES	MO-DA-YR
DIMENSIONS ARE IN MM	DRAWN	
ALL SURFACES 6.3S	CHECKED	
TOLERANCES	APPROVED	
ANGLE ±		
.X ± 0.15		
.XX ± 0.05		
FINISH	WORK ORDER NO	
HEAT TREAT		



케이제이에프(주)  
TOTAL CLAMPING SYSTEMS

TITLE  
**BALL LOCK CYLINDER**

REF DWG NO.	DWG NO	A4
	<b>BLC-0605_ -</b>	
SCALE	TOOL <input type="checkbox"/> PART <input type="checkbox"/> SHEET	OF