

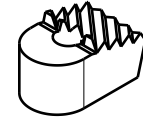

FILE NAME:

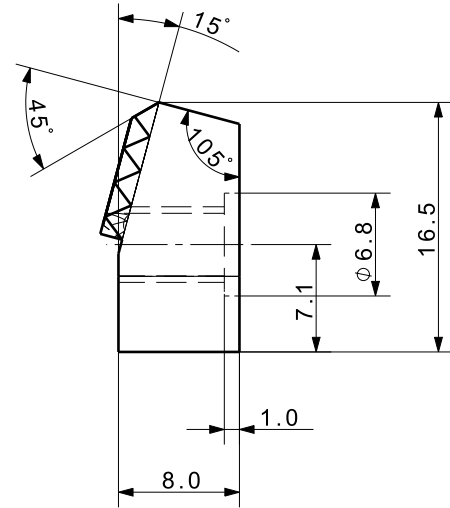
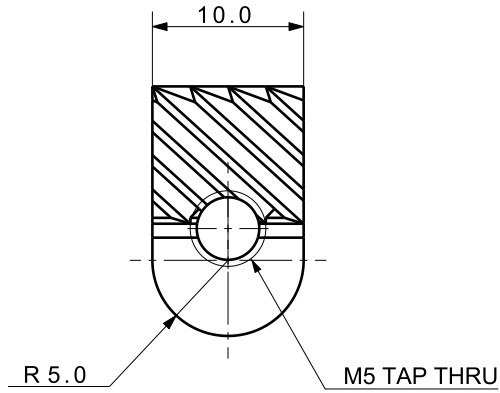

Isometric view (1:1)

UNLESS OTHERWISE SPECIFIED DIMENSIONS ARE IN MM ALL SURFACES TOLERANCES ANGLE           ± X                 ± .X                ± .XX              ±	SIGNATURES	MO-DA-YR	 (주)케이제이에프 TOTAL CLAMPING SYSTEMS	
	DRAWN			
	CHECKED		TITLE	<h1>Tungsten Carbide</h1>
APPROVED				
FINISH	WORK ORDER NO	REF DWG NO.	DWG NO	A4
HEAT TREAT		---	CP-43	
		SCALE	TOOL <input type="checkbox"/> PART <input type="checkbox"/> SHEET	OF