

4

3

2

1

F

F

E

E

D

D

C

C

B

B

A

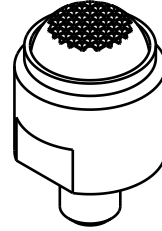

A

REVISIONS				
ZONE	LTR	DESCRIPTION	DATE	APPROVED

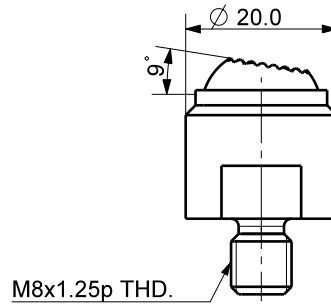
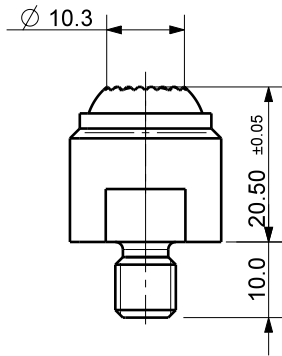
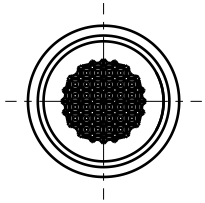

Isometric view (1:1)



UNLESS OTHERWISE SPECIFIED		SIGNATURES		MO-DA-YR	 케이제이에프(주) TOTAL CLAMPING SYSTEMS	
DIMENSIONS ARE IN MM		DRAWN			TITLE SWIVEL PAD	
ALL SURFACES 6.3s		CHECKED				
TOLERANCES		APPROVED				
ANGLE		 				
.X ±						
.X ± 0.15						
.XX ±						
FINISH		WORK ORDER NO		REF DWG NO.	DWG NO	
HEAT TREAT				--	SPD-0800-A	
				SCALE	TOOL <input type="checkbox"/>	PART <input type="checkbox"/>
					SHEET	OF

4

3

2

1

A4