

4

3

2

1

F

F

E

E

D

D

C

C

B

B

A

A

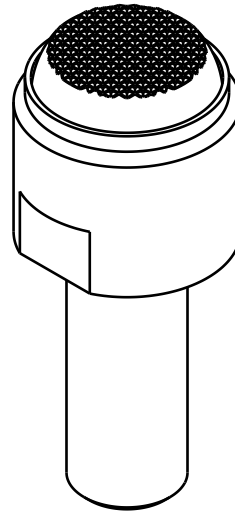
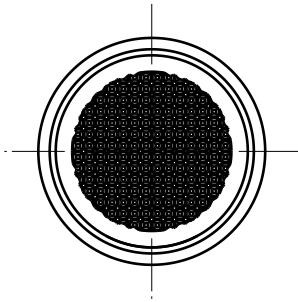

REVISIONS				
ZONE	LTR	DESCRIPTION	DATE	APPROVED

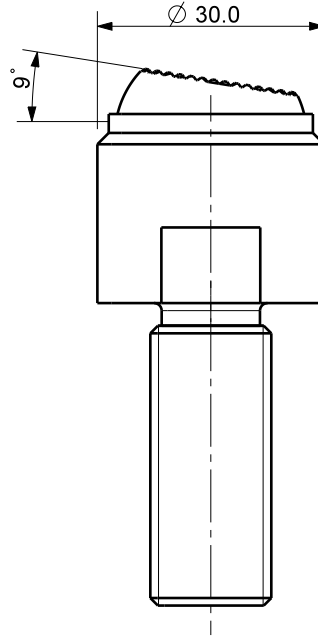
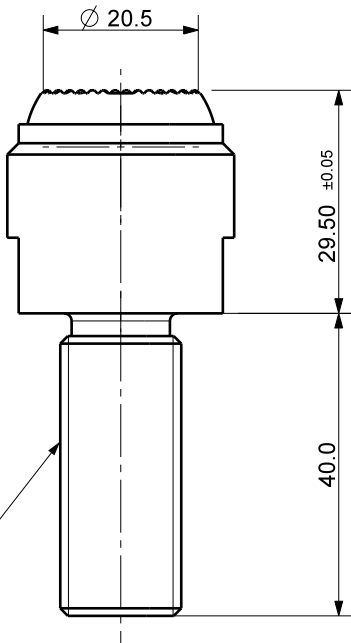

Isometric view (1:1)



M16 x 2.0p THD.

DET.NO	NAME	Q'TY	MAT'L	FINAL SIZES & PART No	REMARK	
UNLESS OTHERWISE SPECIFIED		SIGNATURES		MO-DA-YR		
DIMENSIONS ARE IN MM		DRAWN		 케이제이에프(주) TOTAL CLAMPING SYSTEMS		
ALL SURFACES 6.3s		CHECKED		TITLE		
TOLERANCES		APPROVED		<h1>SWIVEL PAD</h1>		
ANGLE		 				
X. ±		WORK ORDER NO		REF DWG NO.	DWG NO	
.X ± 0.15				--	SPD-1640	A4
.XX ±				SCALE	TOOL <input type="checkbox"/>	PART <input type="checkbox"/>
FINISH		HEAT TREAT				

4

3

2

1