

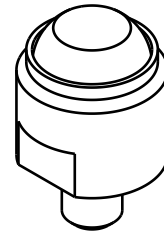

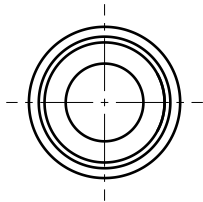

REVISIONS				
ZONE	LTR	DESCRIPTION	DATE	APPROVED

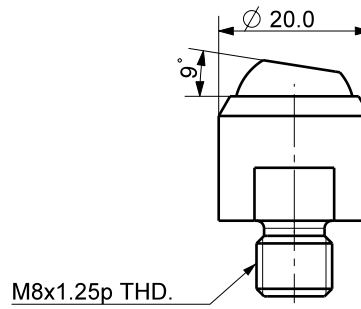
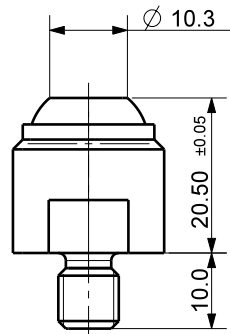

Isometric view (1:1)



DET.NO	NAME	Q'TY	MAT'L	FINAL SIZES & PART No	REMARK		
UNLESS OTHERWISE SPECIFIED		SIGNATURES		MO-DA-YR			
DIMENSIONS ARE IN MM		DRAWN		 케이제이에프(주) TOTAL CLAMPING SYSTEMS			
ALL SURFACES 6.3s		CHECKED				TITLE	
TOLERANCES		APPROVED					
ANGLE X. ± .X ± 0.15 .XX ±		 		<h1>SWIVEL PAD</h1>			
FINISH		WORK ORDER NO				REF DWG NO.	DWG NO
HEAT TREAT				--	SPF-0800-A		
				SCALE	TOOL <input type="checkbox"/> PART <input type="checkbox"/> SHEET OF		

