

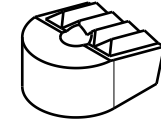

FILE NAME:

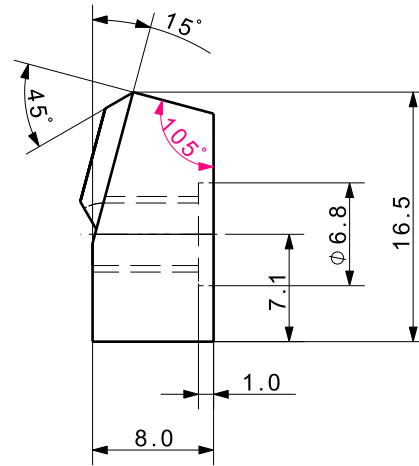
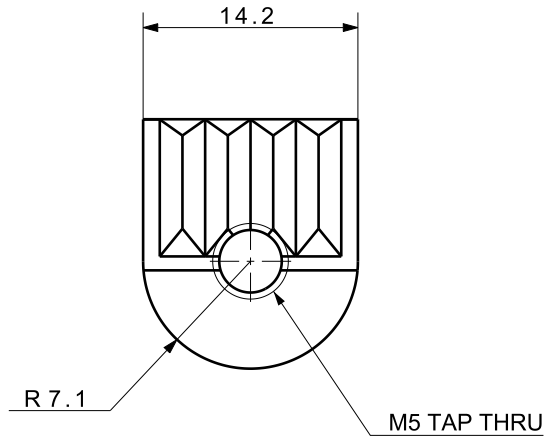

Isometric view (1:1)

UNLESS OTHERWISE SPECIFIED DIMENSIONS ARE IN MM ALL SURFACES TOLERANCES ANGLE ± X ± .X ± .XX ±	SIGNATURES	MO-DA-YR	 (주)케이제이에프 TOTAL CLAMPING SYSTEMS	
	DRAWN			
		CHECKED		Tungsten Carbide
	APPROVED			
FINISH	WORK ORDER NO	REF DWG NO.	DWG NO	A4
HEAT TREAT		---	TCP-21	
		SCALE	TOOL <input type="checkbox"/> PART <input type="checkbox"/> SHEET	OF